

Catalogo Prodotti PilatiGianfranco.it 2025

- **Antigrandine e Antipioggia** (pag. 2)
 - Accessori per Pali (pag. 2)
 - Clips e Placchette (pag. 3)
 - Fermarete e Fermateli (pag. 6)
 - Sistemi di Apertura e Chiusura Rapida Reti (pag. 11)
- **Prodotti in Legno** (pag. 12)
 - Pali in Legno (pag. 13)
 - Staccionate (pag. 13)
- **Riscaldamento** (pag. 14)
 - Legna da Ardere (pag. 14)
 - Pellet e Tronchetti (pag. 15)
 - Fornelli (pag. 17)
- **Antinfortunistica** (pag. 18)
- **Giardinaggio e Agricoltura** (pag. 21)
- **Pali** (pag. 24)
 - Pali in Acciaio (pag. 24)
 - Pali in Cemento (pag. 26)
- **Attrezzature Agricole** (pag. 30)

ANTIGRANDINE E ANTIPIOGGIA

Accessori per Pali



- Copripalo International con viteria (7x7, 7x8, 8x8.5, 9 x9.5,)
- Copripalo per Palo di Legno con viteria (diametro 100, 127, 160)
- Copripalo Testata con viteria (10x12)



- Placchetta Rettangolare per Palo

Clips e Placchette



- Placchetta 2 punte



- Placchetta Ancorplack



- Placchetta K4



- Placchetta Magnum



- Placchetta Ninha



- Placchetta Resia



- Placchetta Rolle

Fermarete e Fermateli



- Ago fermarete in acciaio



- Ancoranet 50 – Fermarete/telo



- Clip Morsa 40 Fermatelo



- Clip Morsa 70 Fermatelo



- Elastico Premontato



- Gancio Amo per Occhielli



- Gancio in Acciaio per Elastico



- Moschettone Autobloccante in PVC



- Moschettone Ovale in PVC Nero



- Pallina con Elastico Fermarete

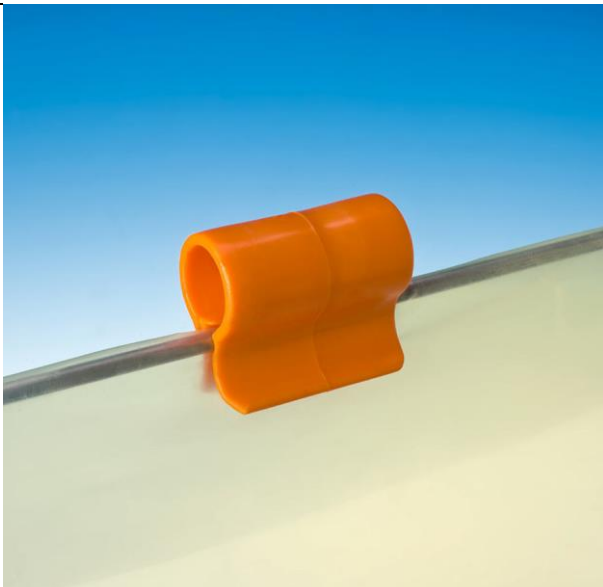

- Pinza Omega in PVC Arancione



- Stopfilm Fermatelo



- Stopnet Fermarete

Sistemi di Apertura e Chiusura Rapida Reti



- Sistema Alza/Abbassa Meccanico

PRODOTTI IN LEGNO

Pali in Legno



- Pali da Vigna Torniti in Okan

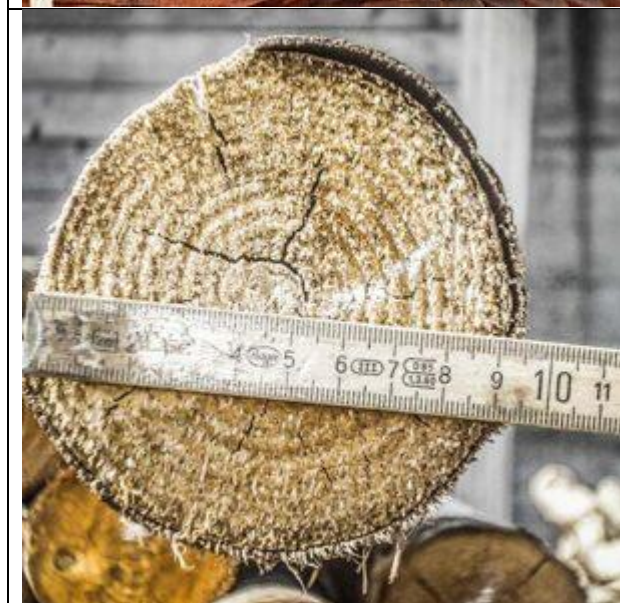

- Palo castagno diam. 8/10 scortecciato con punta



- Palo castagno diam. 10/12 scortecciato con punta
- Palo castagno diam. 12/14 scortecciato con punta
- Palo castagno diam. 12/15 scortecciato con punta

Staccionate



- Staccionata in Legno di Okan

RISCALDAMENTO

Legna da Ardere



- Accendifuoco naturale “Bio Fire”



- Legna da Ardere cm 25
- Legna da Ardere cm 33
- Legna da Ardere cm 50



- Legnetti Accendifuoco

Pellet e Tronchetti

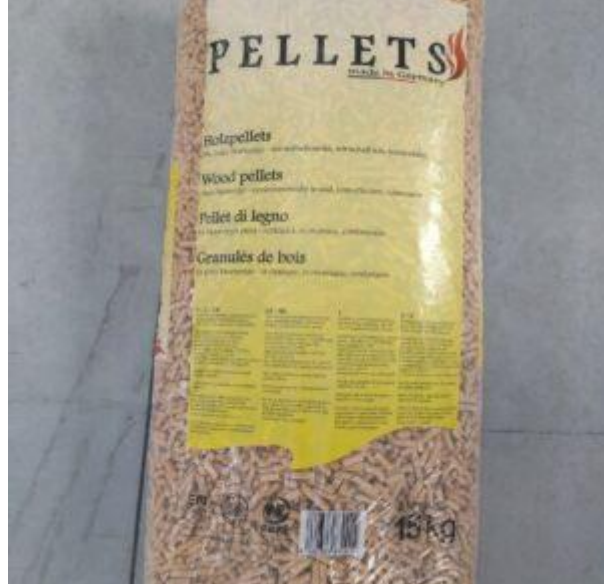
 <p>PANALEX NATURE FIRE</p> <p>PANALEX</p> <p>Pelletti 100% legno di conifera Qualità Premium Certificati UNI EN 14975 - UNI EN 14976 Potere calorifico 14.000 kJ/kg Umidità Max. 7% / Min. 5% Ceneri <math>< 0,2\%</math> Diametro 8 mm Allungamento <math>< 1,2\%</math> Densità specifica 1.20 kg/dm³ Durata 12 kg/ore Codice d'identificazione GH 2012</p>	<ul style="list-style-type: none"> ● Pellet 100% Conifera Panalex
 <p>PELLETS</p> <p>pellets Wood pellets Pellet di legno Granulés de bois</p> <p>15 kg</p>	<ul style="list-style-type: none"> ● Pellet di Conifera
 <p>bukav pelat pellet di faggio beech peller</p> <p>Diametro: 8mm Lunghezza media: 20 mm Umidità: 7% Densità: 1,1kg/dm³ Residuo cenere: 1,1% Potere calorifico: 18,7 MJ/kg (5,2 kWh/kg) Standard di qualità: DIN 51731</p> <p>Diameter: 8mm Average length: 20 mm Humidity: 7% Density: 1,1kg/dm³ Ash residue: 1% Energy value: 18,7 MJ/kg (5,2 kWh/kg) Quality standard: DIN 51731</p> <p>BIOENERGY POINT</p>	<ul style="list-style-type: none"> ● Pellet di Faggio



- Tronchetti in Legno Pressato Naturale

Fornelli



- Fornello a Pellet Ottagonale

Fornello in lamiera finalizzato a combattere gli effetti delle gelate primaverili. Questo bruciatore rappresenta una soluzione molto interessante, **progettata interamente da noi.**

La prevenzione delle gelate sulle colture di **vite, ciliegio, albicocco, pesco, melo e piccoli frutti**, di questi tempi, si rivela un'arma fondamentale per garantire alle aziende agricole la **salvezza del raccolto**. Soprattutto negli ultimi anni, a causa degli ormai noti cambiamenti climatici, **spesso le condizioni meteorologiche possono riservarci eventi molto più estremi e imprevedibili che in passato**, con tutto ciò che ne consegue soprattutto in agricoltura.

Questi fornelli possono essere inseriti uno nell'altro per agevolarne il trasporto e lo stoccaggio, in modo da ottimizzare gli spazi per la gestione di magazzino.

Per maggiori informazioni
CHIAMA ORA! [0463/625356](tel:0463625356)

ANTINFORTUNISTICA



- Scarpa Antinfortunistica 80087-00L Stelvio



- Scarpa Antinfortunistica 88087-13L Stelvio



- Scarpa Antinfortunistica 91253-11L Pasitos



- Scarpa Antinfortunistica 91289-00L Pasitos High



- Scarpa Antinfortunistica 91328-03 Cuban



- Scarpa Antinfortunistica 91355-00L Meneito



- Scarpa Antinfortunistica 92195-00L Dance

GIARDINAGGIO E AGRICOLTURA

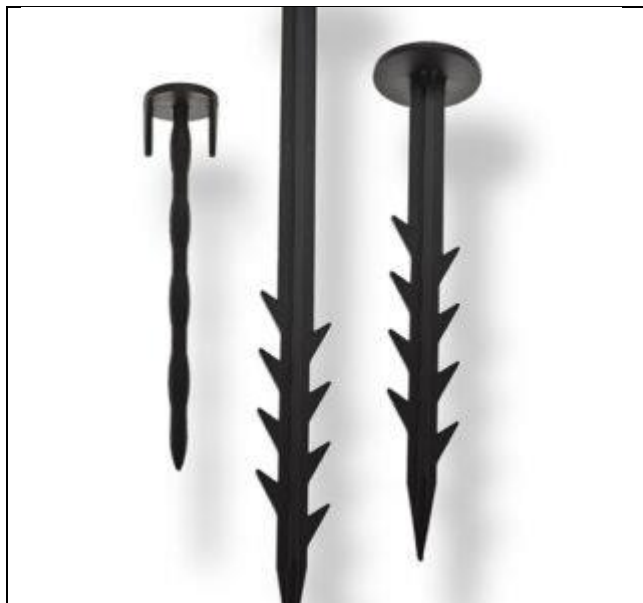

- Chiodi Fermatelo



- Forbici da Potatura Gielle



- Forbici da Potatura Loewe

	<ul style="list-style-type: none"> • Potatore Telescopico
	<ul style="list-style-type: none"> • Seghetto Pieghevole
	<ul style="list-style-type: none"> • Sementi per Inerbimento Frutteto e Giardino (Erba)



- Sementi per Inerbimento Mordente (Erba)



- Tagliarami a Cuneo con Lama Dritta
- Tagliarami a Cuneo con Lama Curva



- Tagliarami a Manico Lungo M

PALI IN ACCIAIO

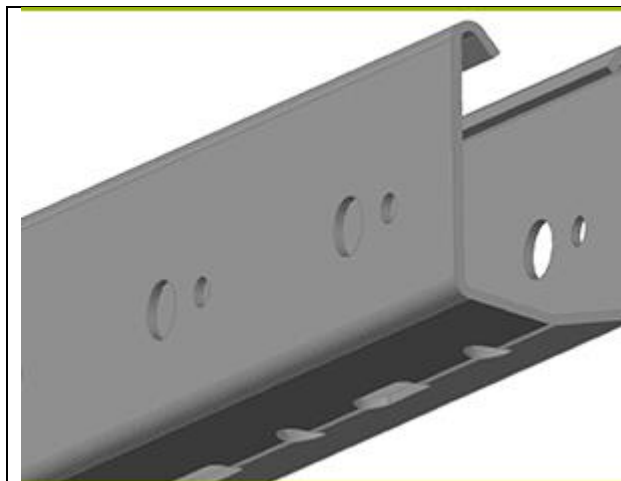

- Palo di Testata EP

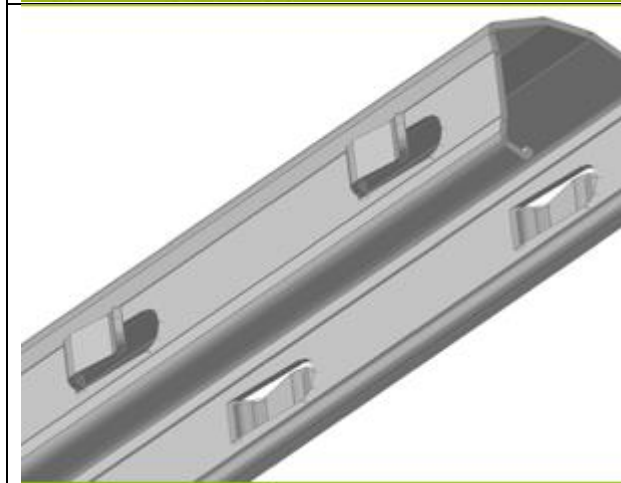

- Palo Interfilare Tipo C

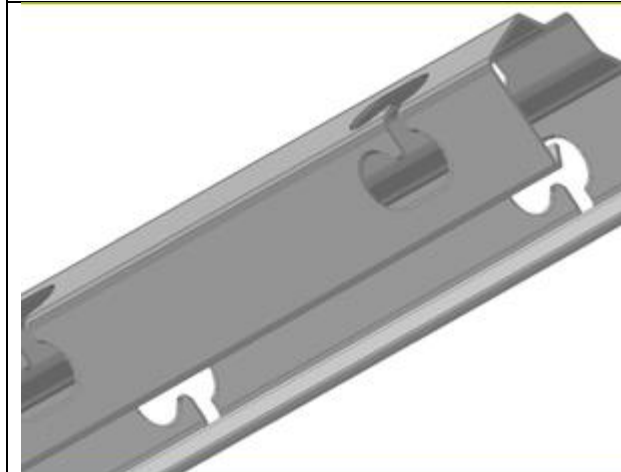

- Palo Interfilare Tipo D (65)

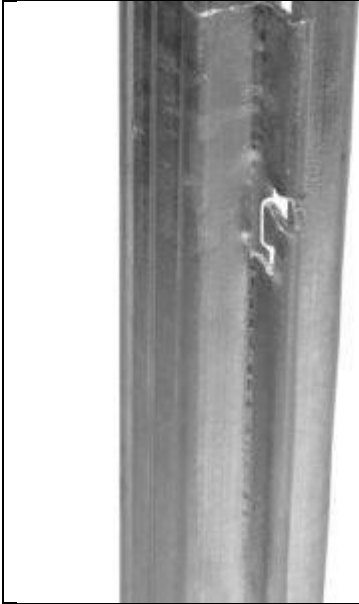

- Palo Interfilare Tipo E

PALI IN CEMENTO



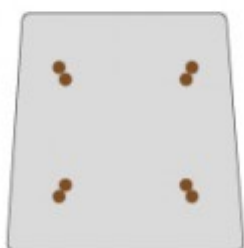

- Palo in Cemento 5x5



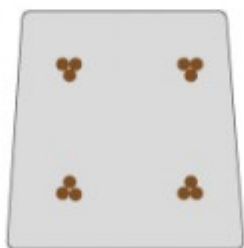

- Palo in Cemento 7x7

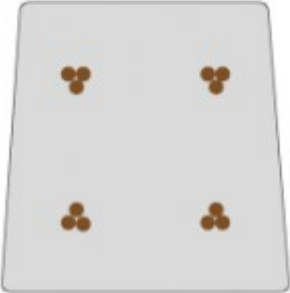

- Palo in Cemento 7x7 Rinforzato

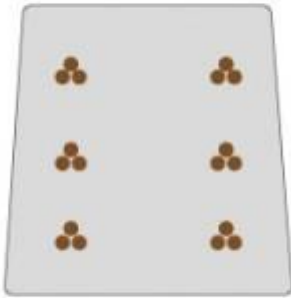
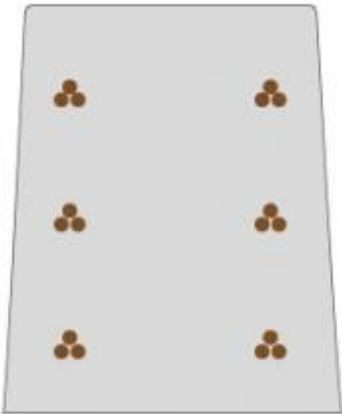
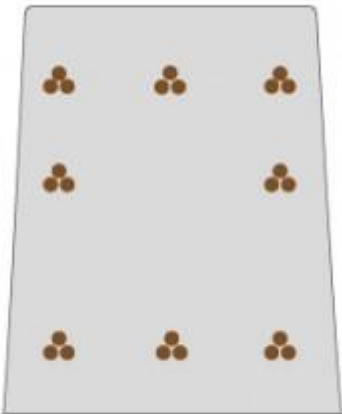
	<ul style="list-style-type: none"> • Palo in Cemento 7x8
	<ul style="list-style-type: none"> • Palo in Cemento 7x8 Rinforzato
	<ul style="list-style-type: none"> • Palo in Cemento 8.5x8.5

	<ul style="list-style-type: none"> • Palo in Cemento 8.5x8.5 Rinforzato
	<ul style="list-style-type: none"> • Palo in Cemento 8x12
	<ul style="list-style-type: none"> • Palo in Cemento 8x12 Rinforzato

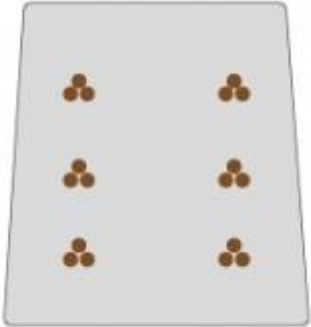
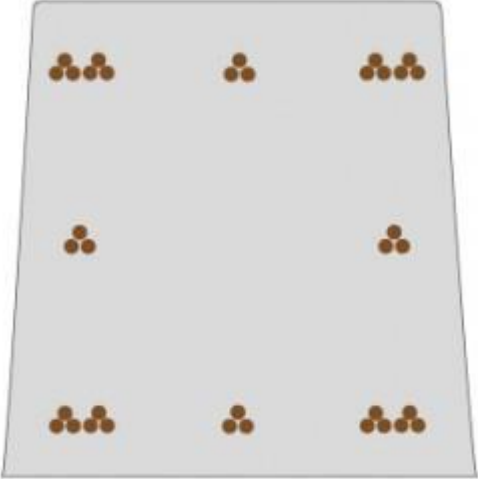
	<ul style="list-style-type: none"> • Palo in Cemento 9x9.5
	<ul style="list-style-type: none"> • Palo in Cemento 9x9.5 Rinforzato
	<ul style="list-style-type: none"> • Palo in Cemento 13x14

ATTREZZATURE AGRICOLE



- Carro per la Raccolta